

Blue Brixx

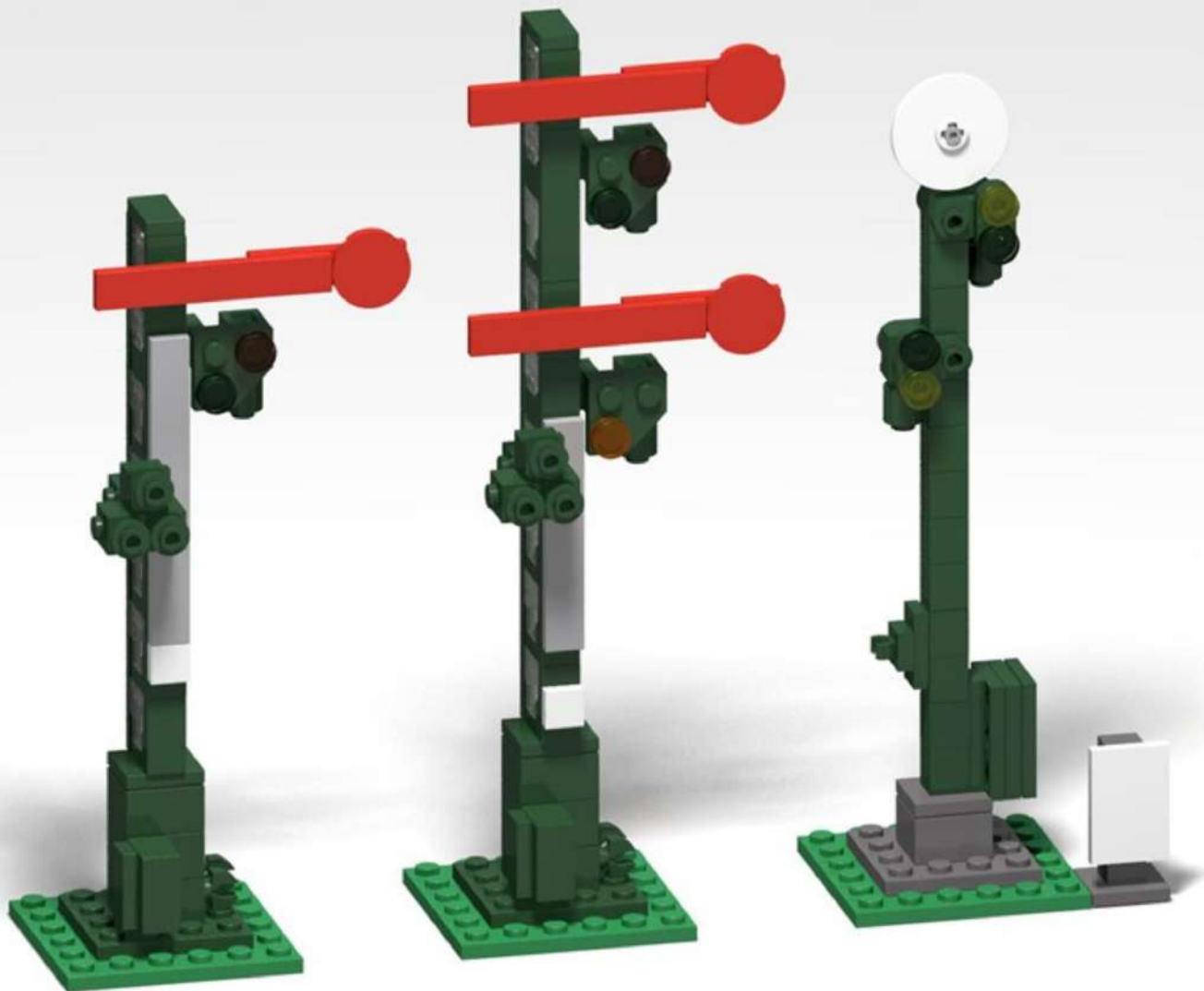

2x



1

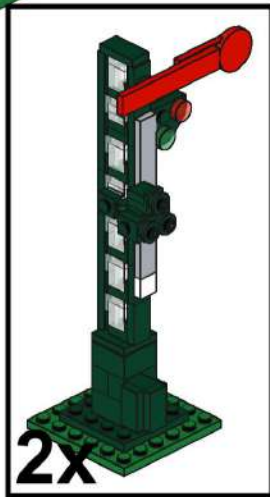
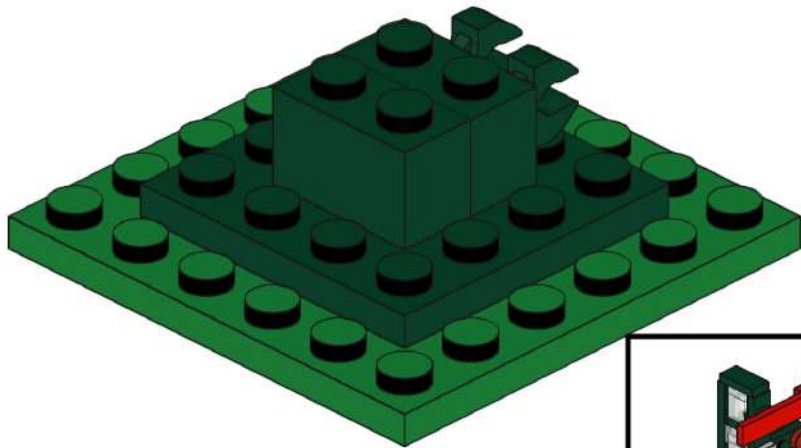
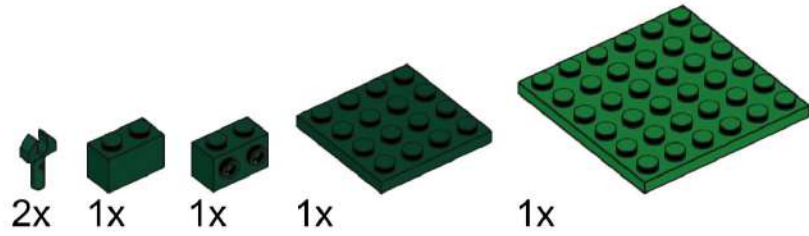

2

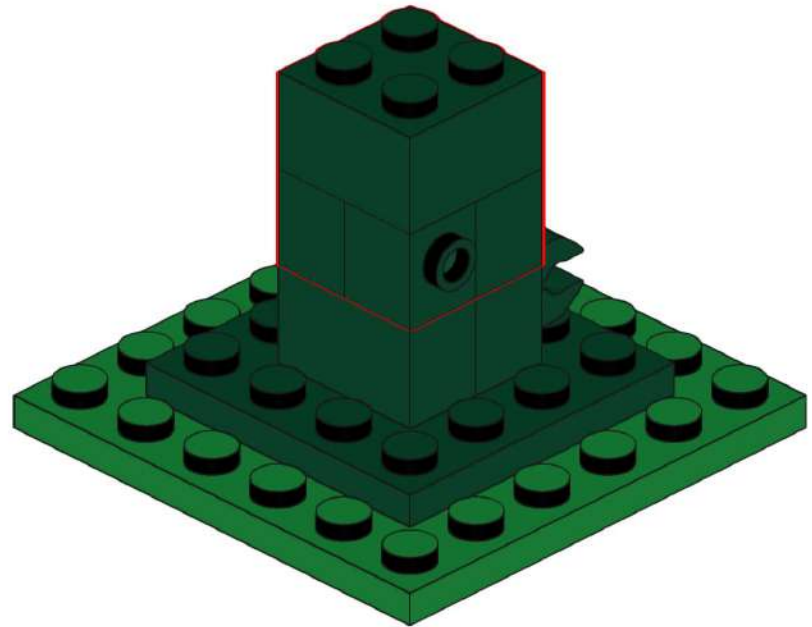
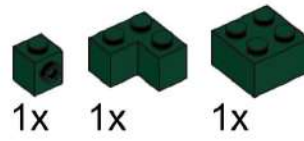

3

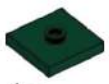

1x



1x



1x

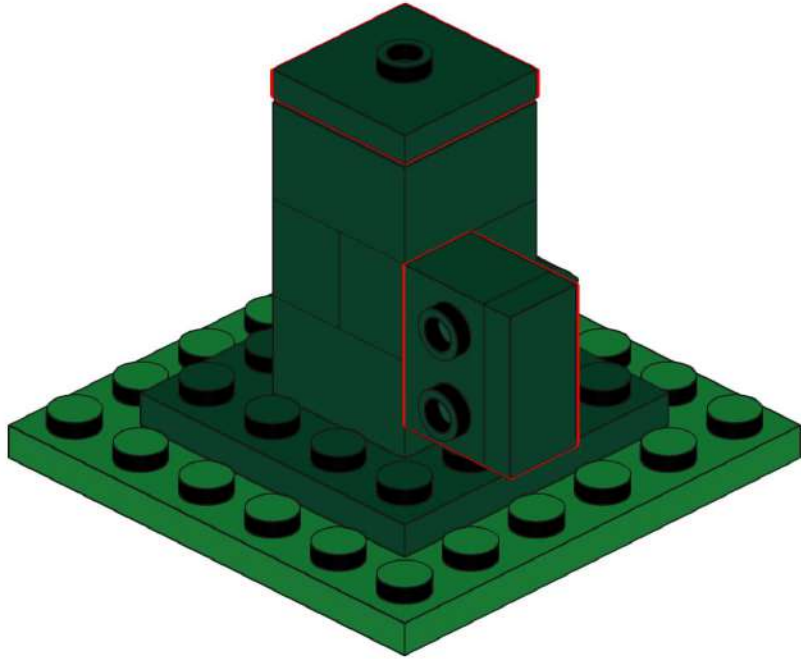

4



1x

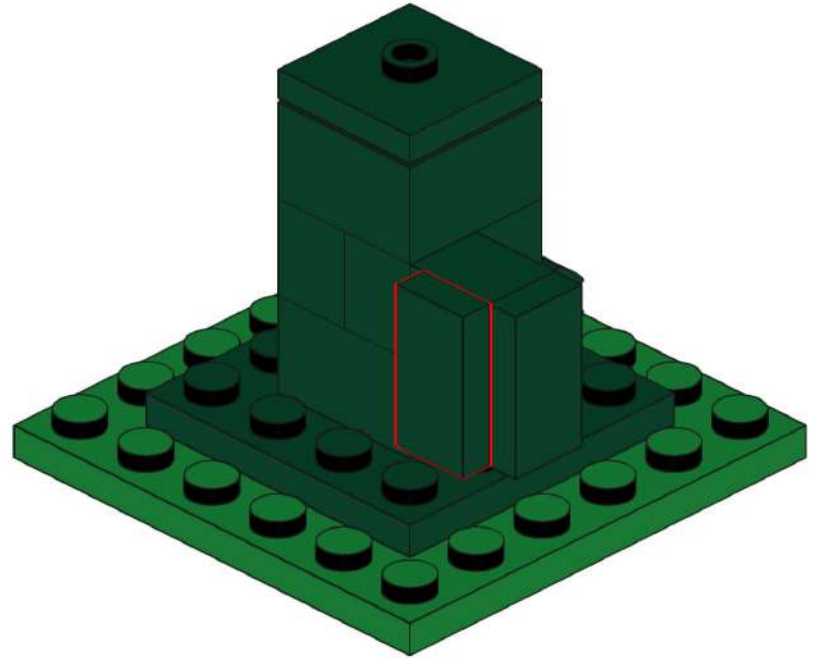

5

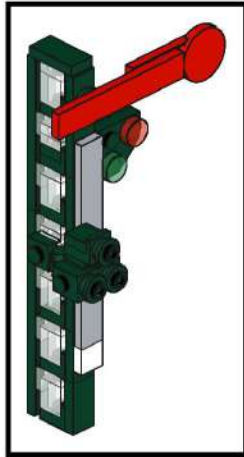

6

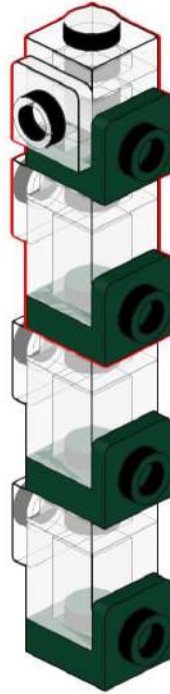
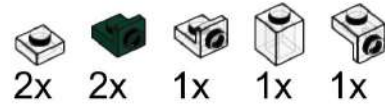

7

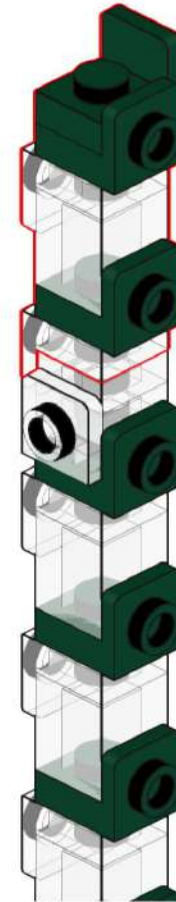
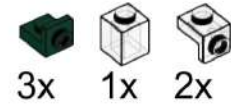

8

- 2x
- 1x
- 1x
- 1x
- 2x

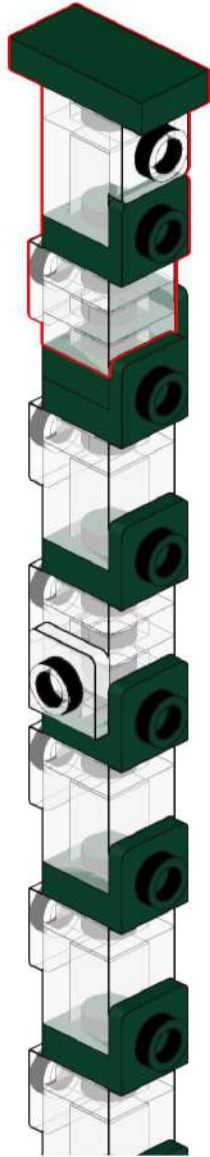

9



- 1x
- 1x

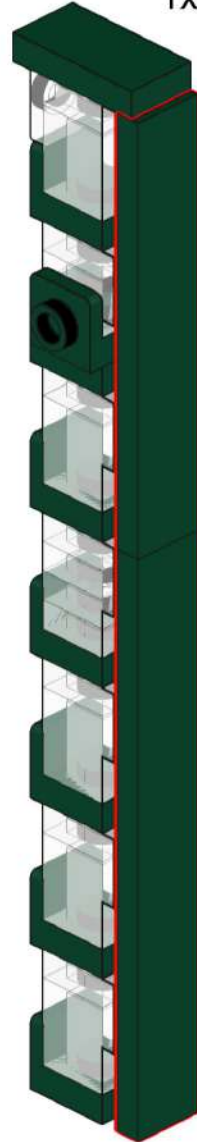

10



- 1x
- 1x
- 4x
- 1x

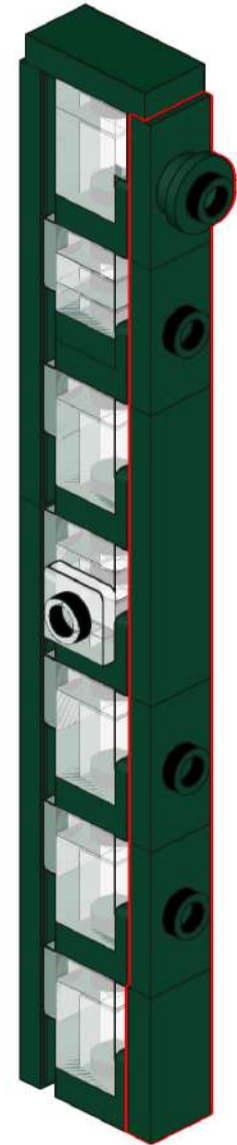

11

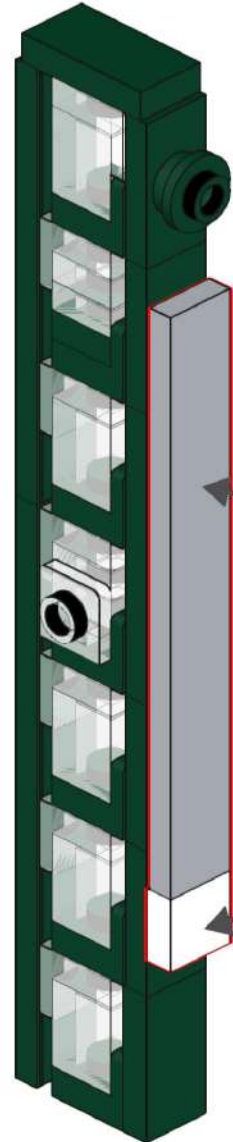
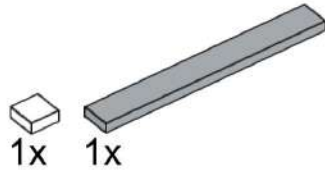

Wählbar, je nach
Position auf der Anlage!

Selectable, depending
on the position on the
layout!

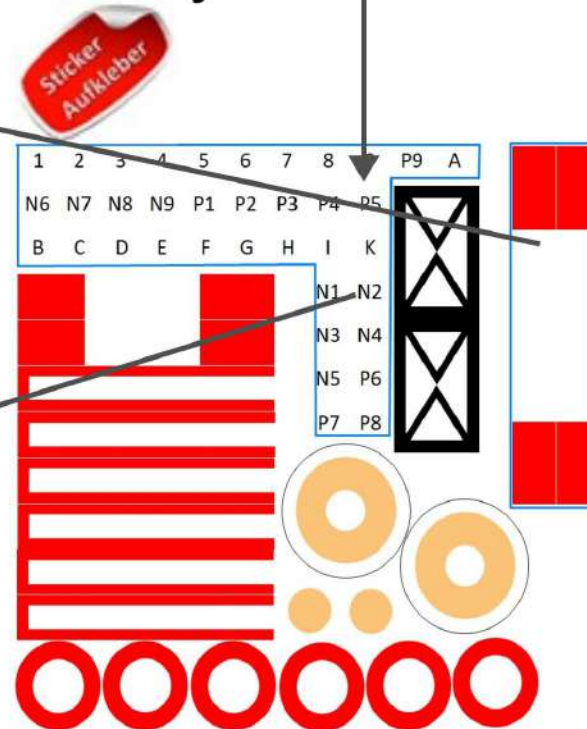

12

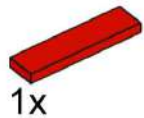

1x

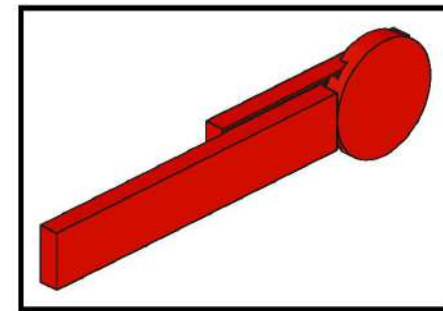
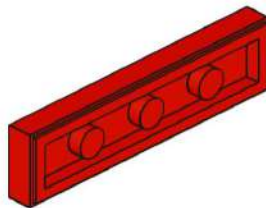

13



3x

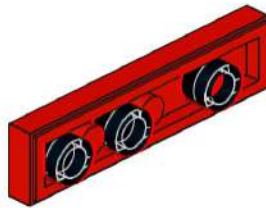

14

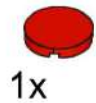

1x

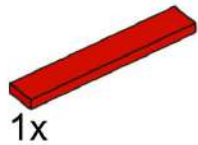

1x

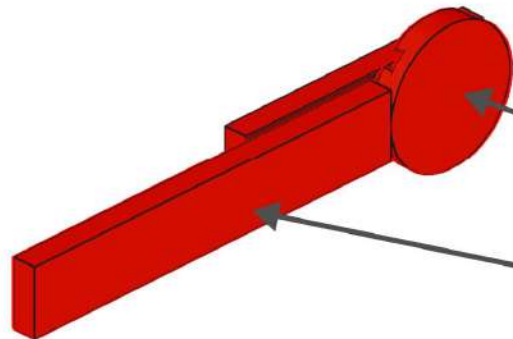

1	2	3	4	5	6	7	8	9	P9	A	
N6	N7	N8	N9	P1	P2	P3	P4	P5			
B	C	D	E	F	G	H	I	K			
								N1	N2		
								N3	N4		
								N5	P6		
								P7	P8		

16

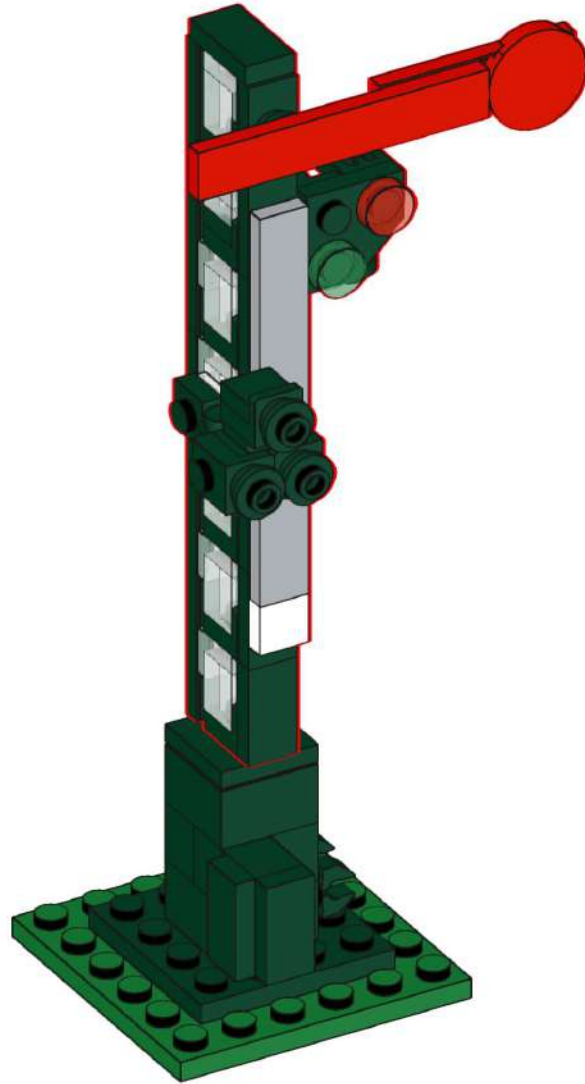

17



1x

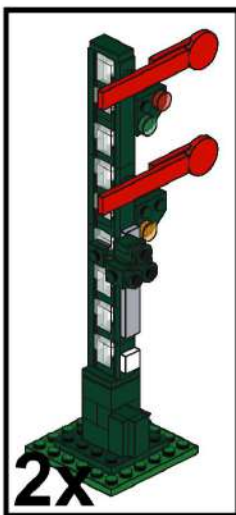

2x

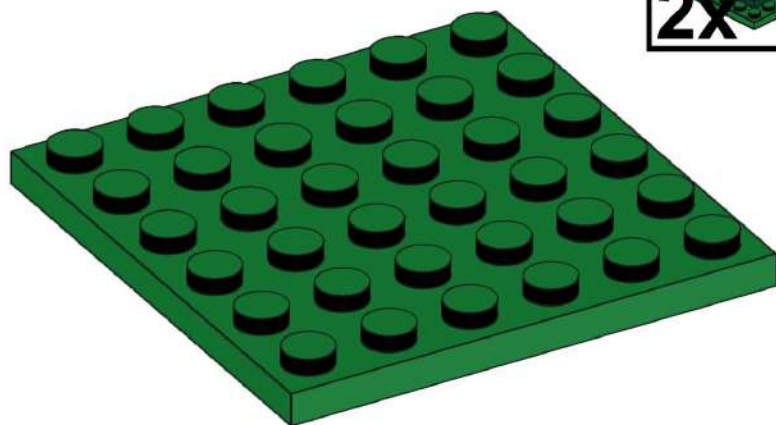

18



1x

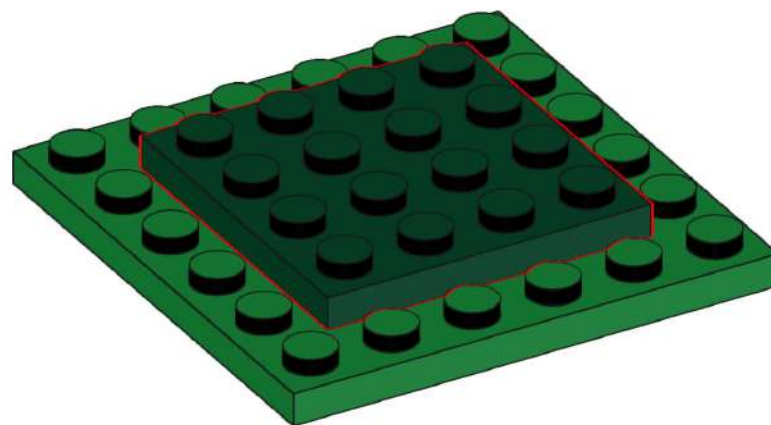

19

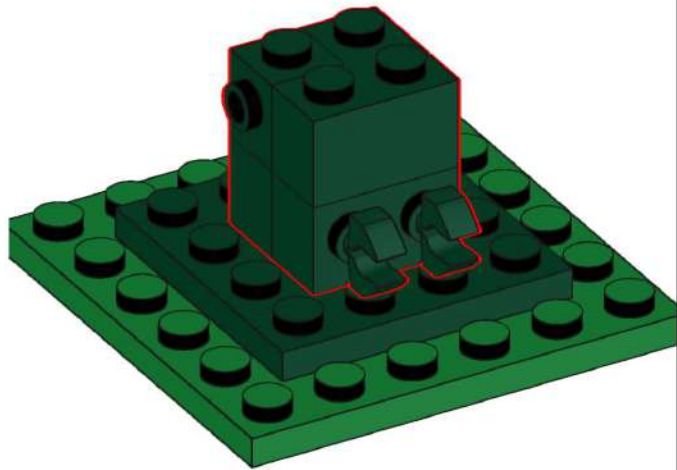
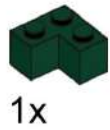
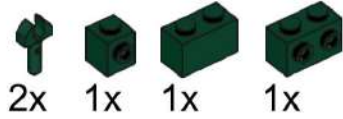

20

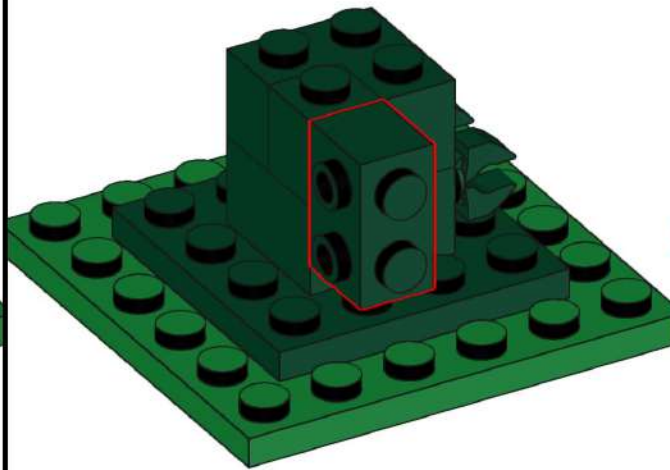

21

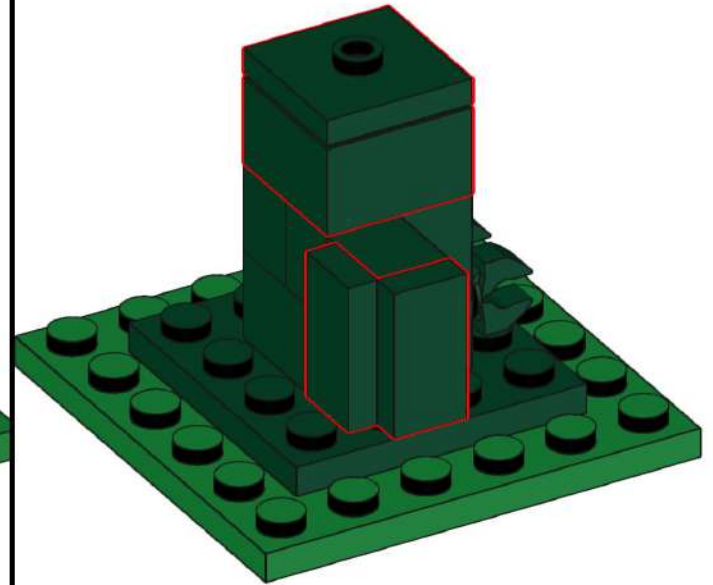
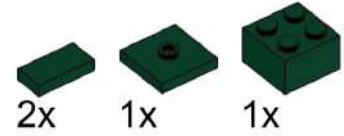

22

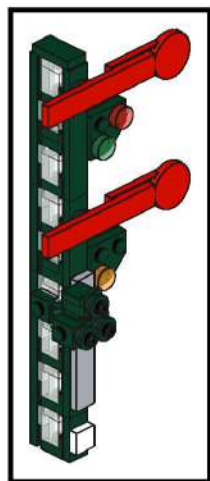

23

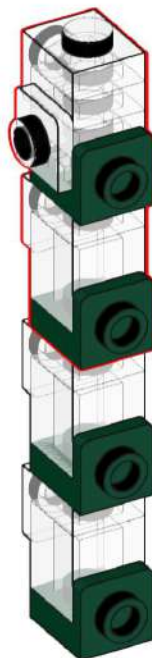

24

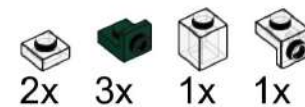

28



- 2x 
- 2x 
- 5x 
- 1x 

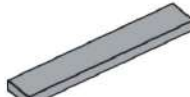

29

- 1x 
- 1x 



Wählbar, je nach
Position auf der Anlage!

Selectable, depending
on the position on the
layout!

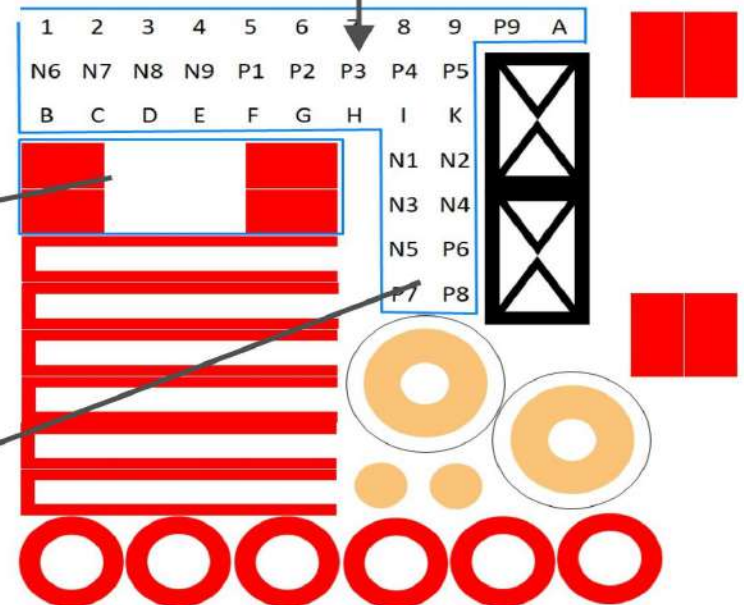

30

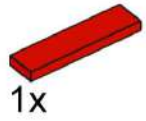

1x

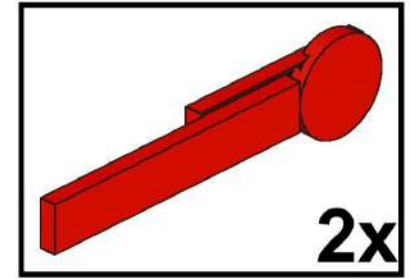
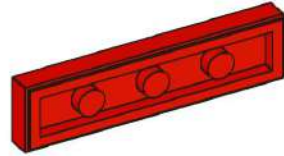

2x

31



3x

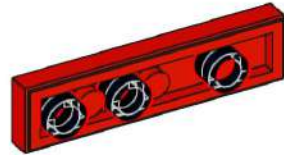

32

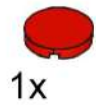

1x

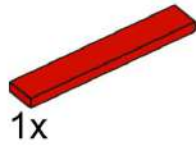

1x

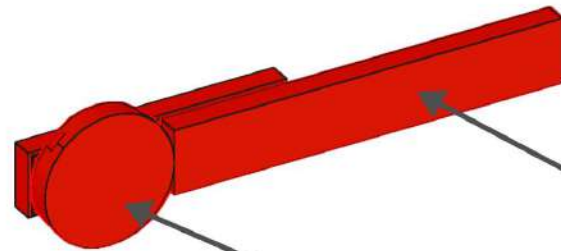

1	2	3	4	5	6	7	8	9	P9	A
N6	N7	N8	N9	P1	P2	P3	P4	P5		
B	C	D	E	F	G	H	I	K		
								N1	N2	
								N3	N4	
								N5	P6	
								P7	P8	

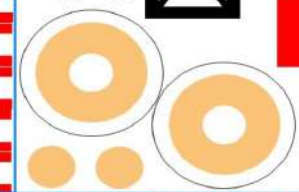
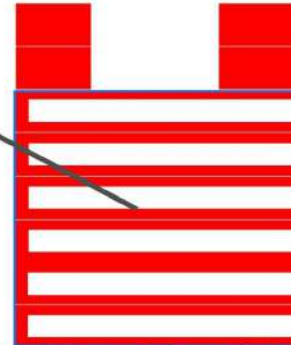

34

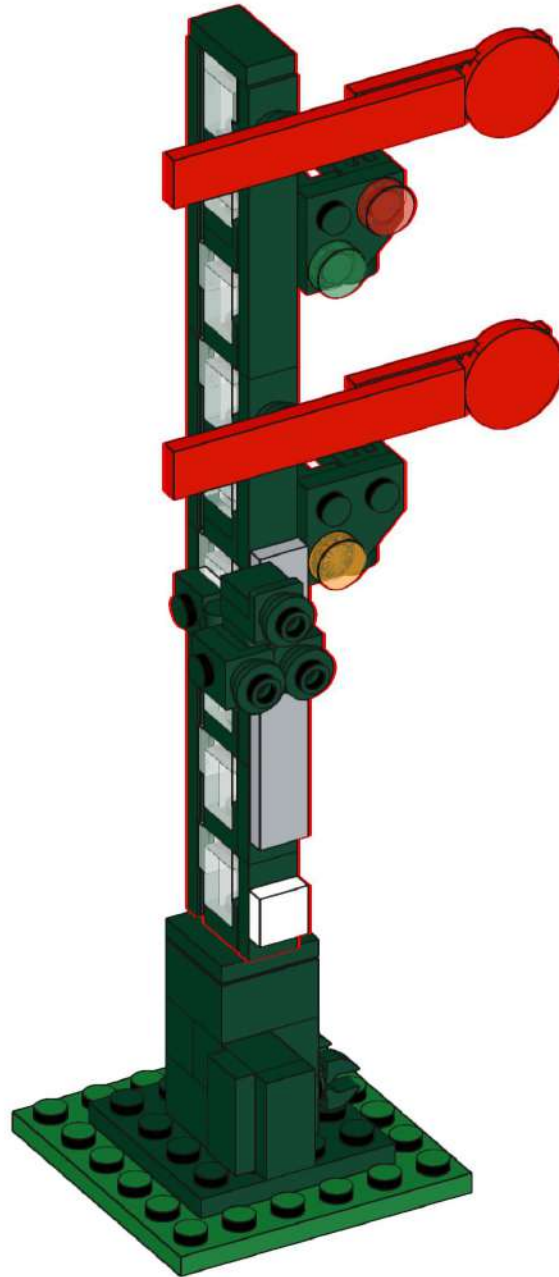

35

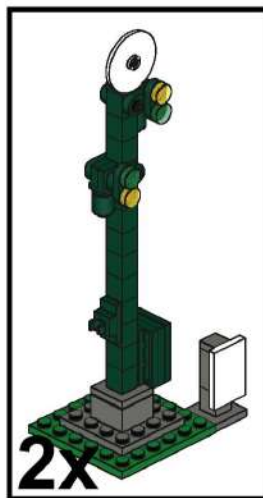
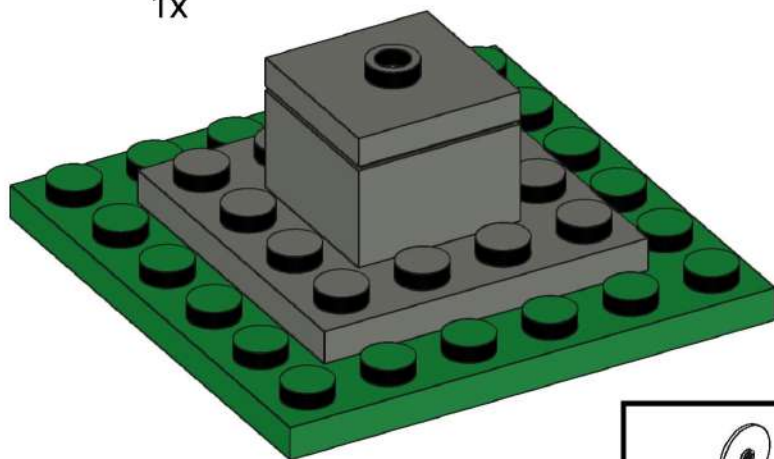
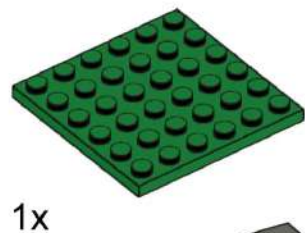
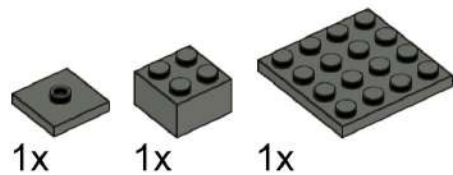

36

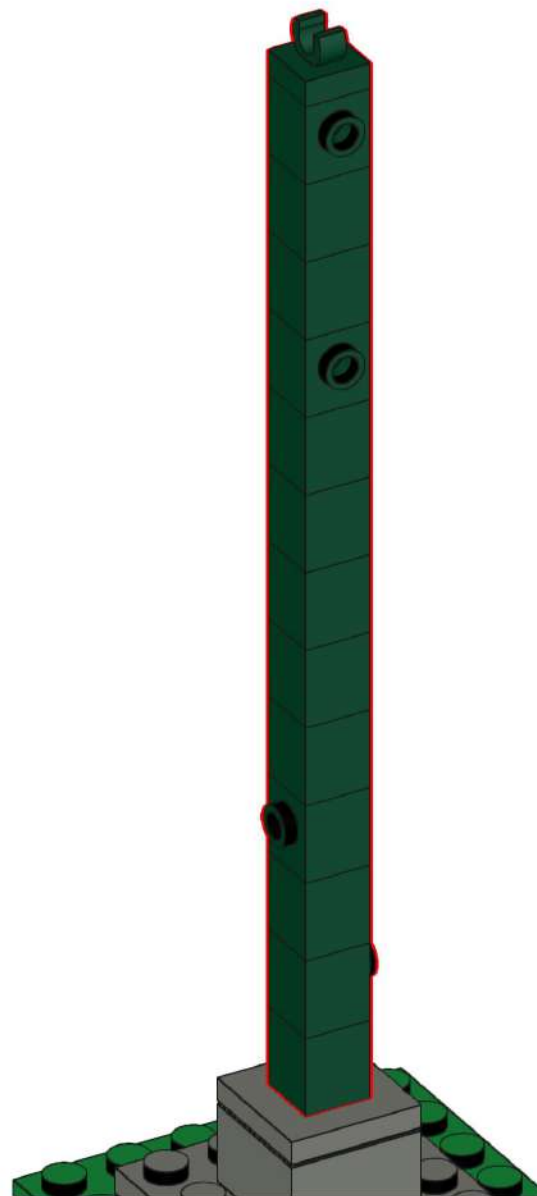
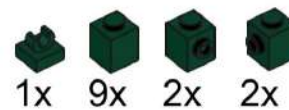

37

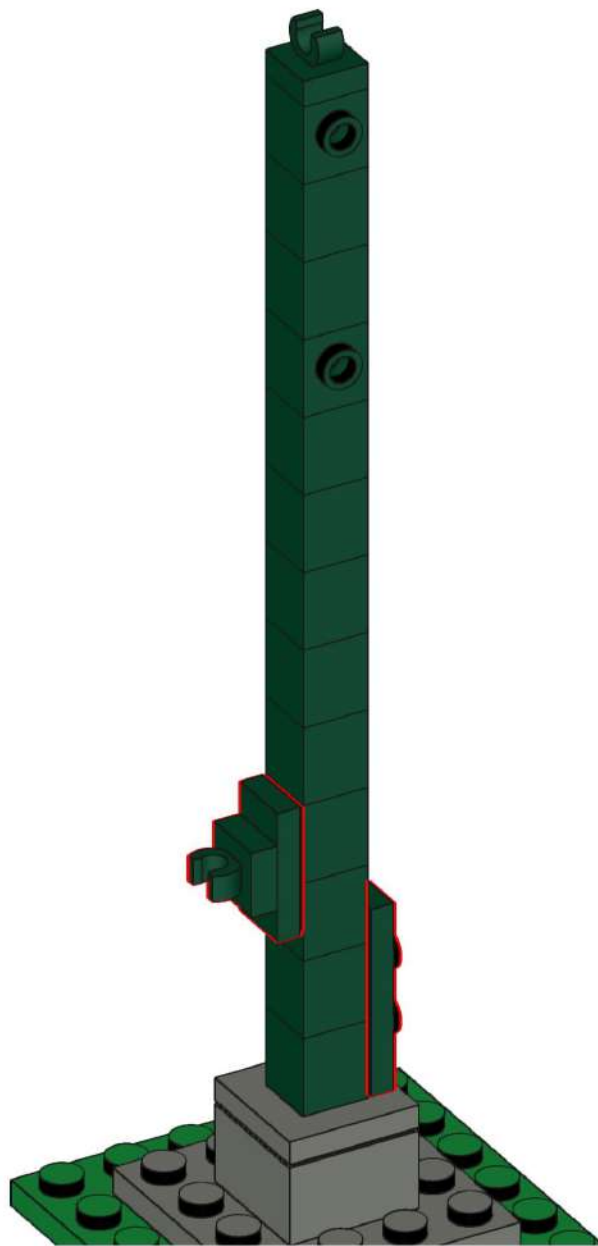
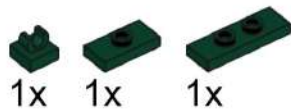

38

2x 2x 2x 2x

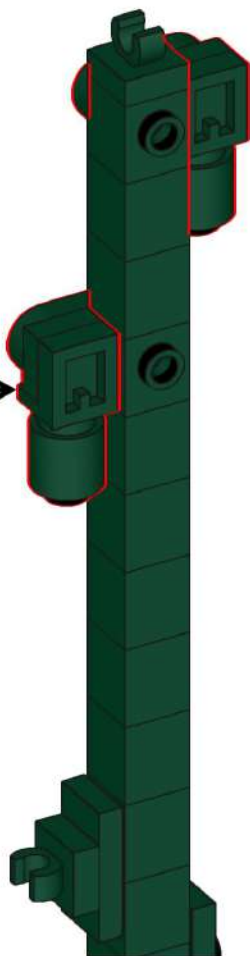
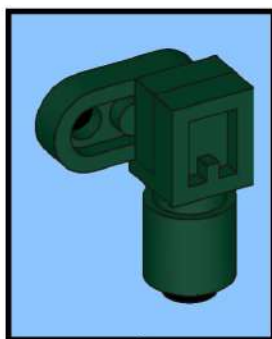
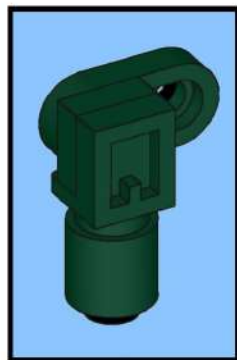

39

2x

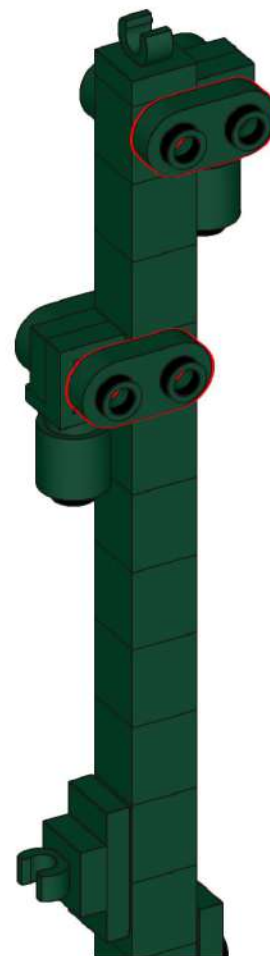

40

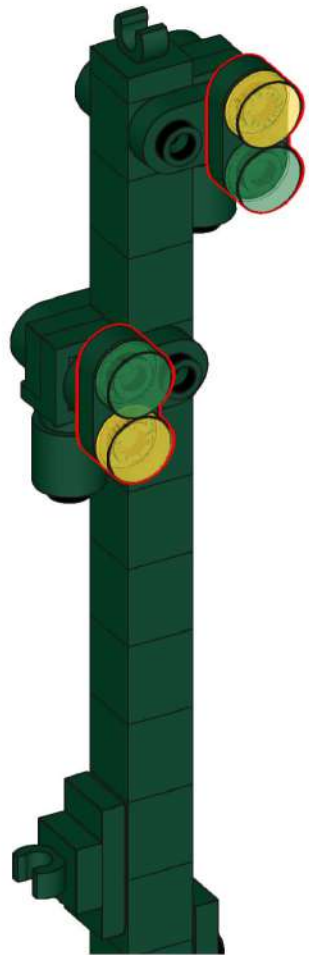

41

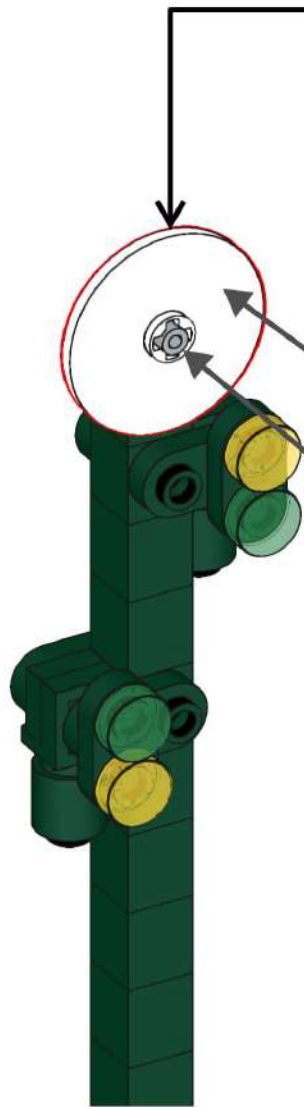
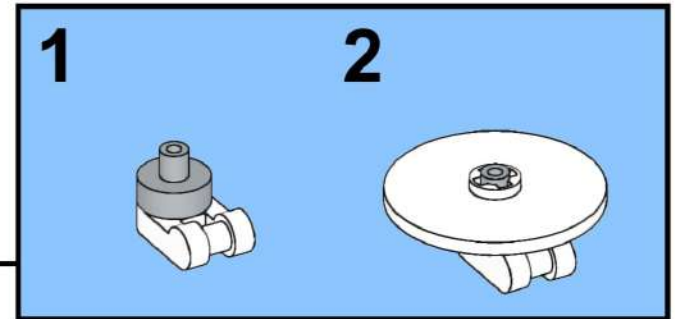
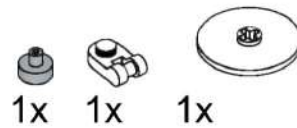

1	2	3	4	5	6	7	8	9	P9	A	
N6	N7	N8	N9	P1	P2	P3	P4	P5			
B	C	D	E	F	G	H	I	K			
							N1	N2			
							N3	N4			
							N5	P6			
							P7	P8			

42

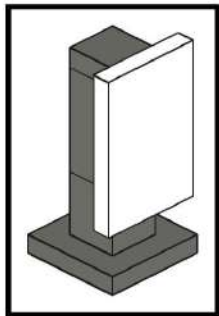
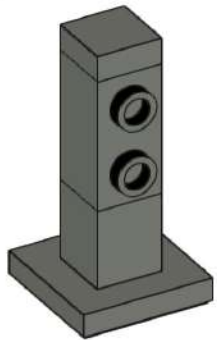
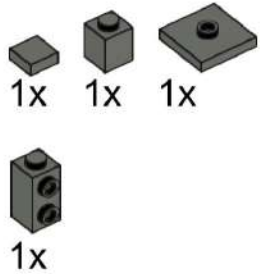

43

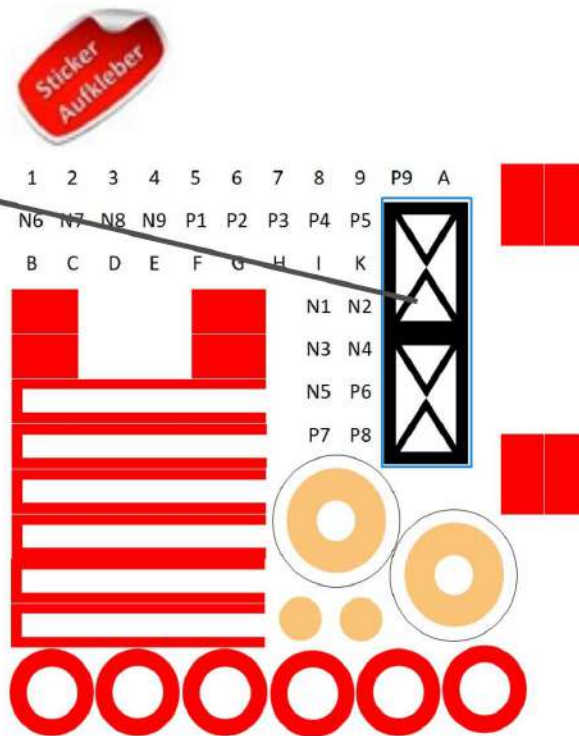
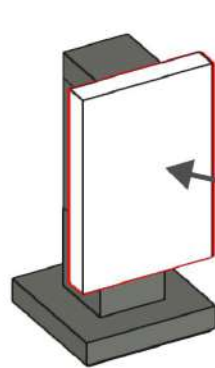
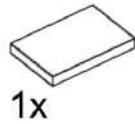

44

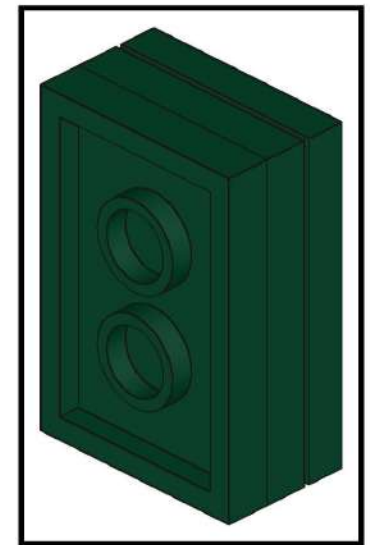
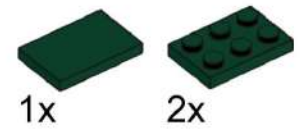

46

